

CS 248 Assignment 2

Polygon Scan Converter

CS248

Presented by Abe Davis

Stanford University

October 17, 2008

Announcements...



- **First thing: read README.animgui. It should tell you everything you need to know about the GUI.**
- **Post questions first to the newsgroup (su.class.cs248) and check there for answers to common questions.**

Getting Started



- **Read the project handout carefully!**
- <http://graphics.stanford.edu/courses/cs248-08/proj2.html>
- **Look at the code**
 - “README.files” talks about what different source files do, and where to find examples. Ignore the part about testing on the myth machines – we will test using the VM.
 - “README.animgui” explains what to do once the program is running. How to create polygons, load/save object files, and create animations (we’ll go over most of this today too).

Development



- **The interface is built using a cross platform library called GLUT.**
 - You won't need to change the interface unless you add features (extra credit). In that case, see the GLUT manual in `assignments/assignment2/docs`.
- **You can develop and test this program on Windows or Mac, just make sure it works on the VM!**
- **When we give you the sample images, don't worry about matching them exactly. Use the images to get an idea of correct behavior.**

The Interface



(The interface is described in detail in README.animgui)

- **A few key points:**
- **(Shift + Left click) : add vertices.**
- **(Left click) : completes the polygon you're editing, or allows you to select and drag vertices.**
- **(Right click) : drag the whole polygon**
- **The program we give you already handles all the editing functionality, you just need to work on the rendering.**

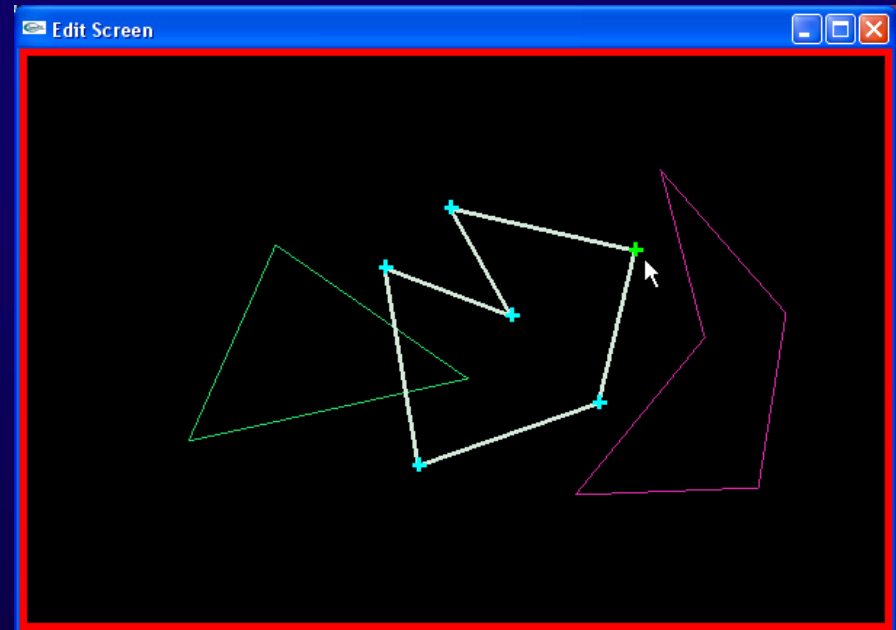

When you're ready to see the scene, hit the "Render" button.

Scan Conversion (Rasterization)



- **The Algorithm** (page 98 in Computer Graphics FvDFH second ed.)
- Create an *Edge Table* for the polygon being rendered, sorted on y .
 - Don't include horizontal edges, they are handled by the edges they connect to (see page 95 in text).

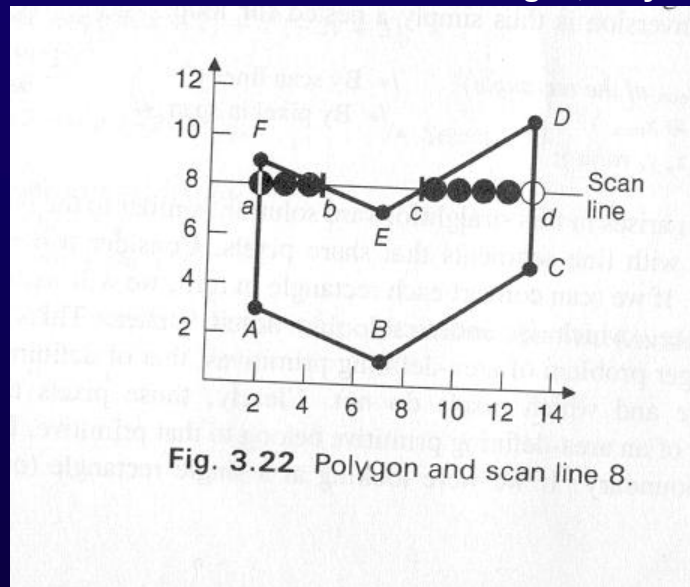

Fig. 3.22 Polygon and scan line 8.

Note: x_{min} is the x at the minimum y for the edge, not necessarily the minimum x of the edge. Hence $x_{min} = 7$ for edge AB .

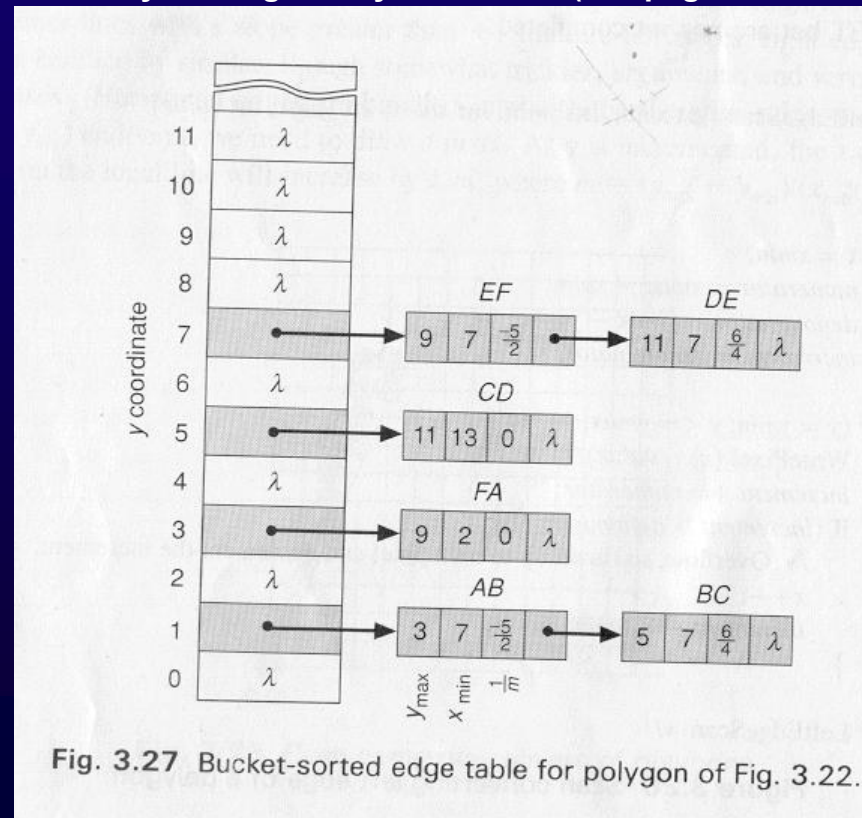

Fig. 3.27 Bucket-sorted edge table for polygon of Fig. 3.22.

Scan Conversion (cont.)



- Once you have your *Edge Table* (ET) for the polygon, you're ready to step through y coordinates and render scan lines:
- 1. Set y to the first non-empty bucket in the ET. This is bucket 1 in the example.
- 2. Initialize the *Active Edge Table* (AET) to be empty. The AET keeps track of which edges cross the current y scan line.
- 3. Repeat the following until the AET and ET are empty:
 - 3.1 Add to the AET the ET entries for the current y. (edges AB, BC in example)
 - 3.2 Remove from the AET entries where $y = y_{max}$. (none at first in example)
 - Then sort the AET on x. (order: {AB, BC})
 - 3.3 Fill in pixel values on the y scan line using the x coordinates from the AET. Be wary of parity— use the even/odd test to determine whether to fill (see next slide).
 - 3.4 Increment y by 1 (to the next scan line).
 - 3.5 For every non-vertical edge in the AET update x for the new y (calculate the next intersection of the edge with the scan line).
- Note: the algorithm in the book (presented here and in course lecture notes) attempts to fix the problems that occur when polygons share an edge, by not rasterizing the top-most row of pixels along an edge.

Active Edge Table Example



- Example of an AET containing edges {FA, EF, DE, CD} on scan line 8:
- 3.1: ($y = 8$) Get edges from ET bucket y (none in this case, $y = 8$ has no entry)
- 3.2: Remove from the AET any entries where $y_{max} = y$ (none here)
- 3.3: Draw scan line. To handle multiple edges, group in pairs: {FA,EF}, {DE,CD}
- 3.4: $y = y+1$ ($y = 8+1 = 9$)
- 3.5: Update x for non-vertical edges, as in simple line drawing.

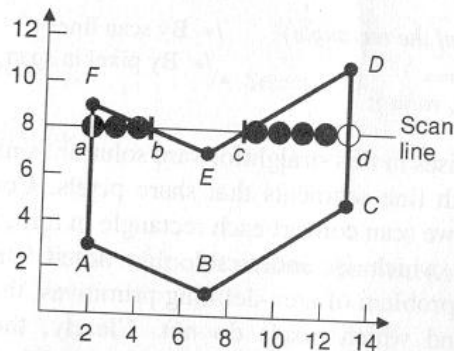

Fig. 3.22 Polygon and scan line 8.

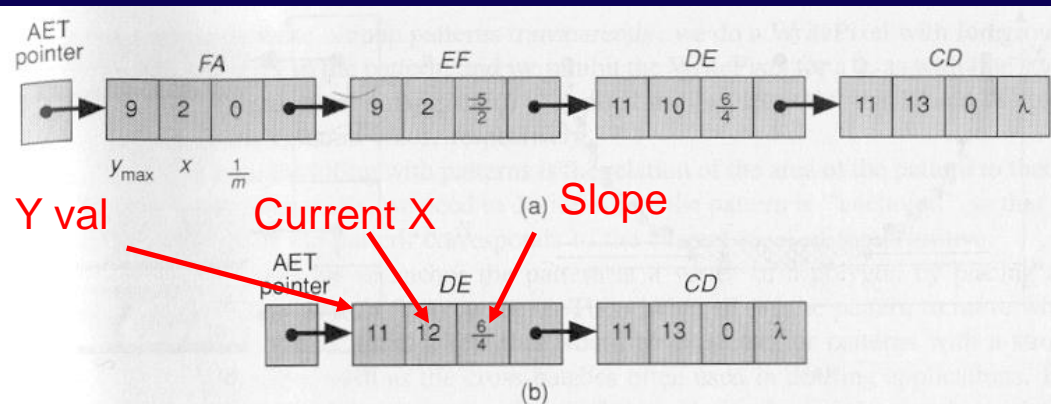

Fig. 3.28 Active-edge table for polygon of Fig. 3.22. (a) Scan line 9. (b) Scan line 10. (Note DE 's x coordinate in (b) has been rounded up for that left edge.)

Active Edge Table Example (cont.)



- 3.1: ($y = 9$) Get edges from ET bucket y (none in this case, $y = 9$ has no entry in ET)
 - “Scan line 9” shown in fig 3.28 below
- 3.2: Remove from the AET any entries with $y_{max} = y$ (remove FA, EF)
- 3.3: Draw scan line between {DE, CD}
- 3.4: $y = y+1 = 10$
- 3.5: Update x in {DE, CD}
- 3.1: ($y = 10$) (Scan line 10 shown in fig 3.28 below)
- And so on...

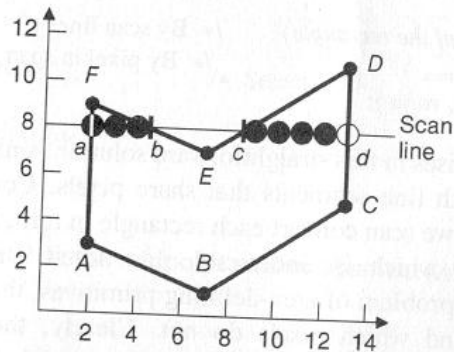

Fig. 3.22 Polygon and scan line 8.

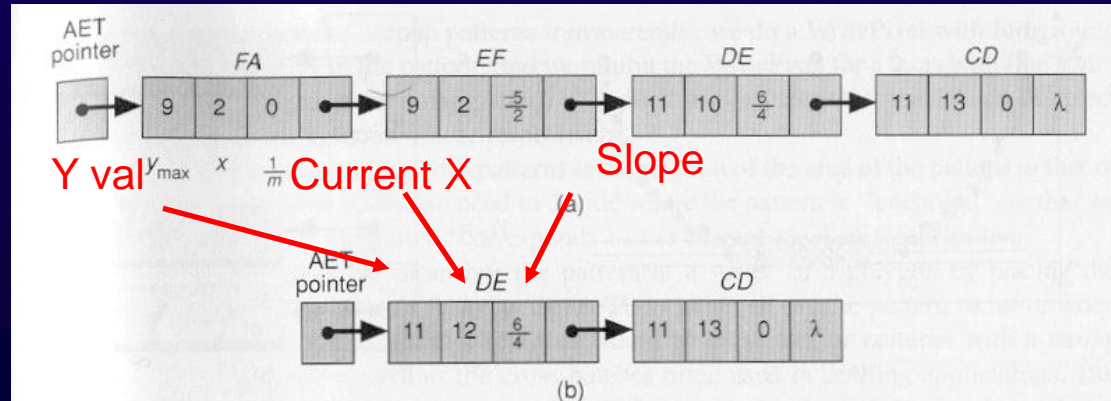
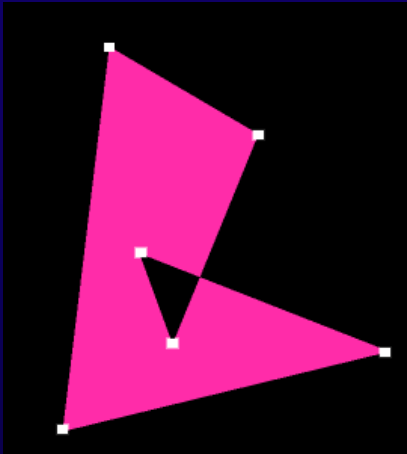

Fig. 3.28 Active-edge table for polygon of Fig. 3.22. (a) Scan line 9. (b) Scan line 10. (Note DE 's x coordinate in (b) has been rounded up for that left edge.)

Test Images



- **Some cases you should test:**
(vertices added for illustration)



Self-intersecting polygons,
to test parity.

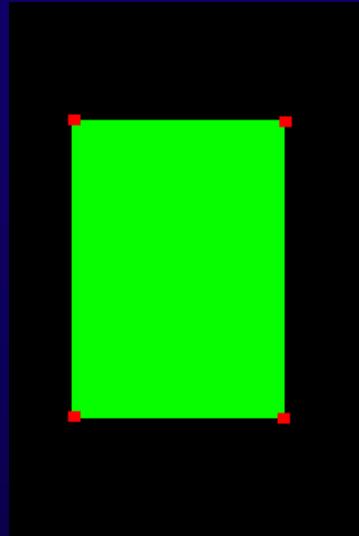

Horizontal and
Vertical edges.

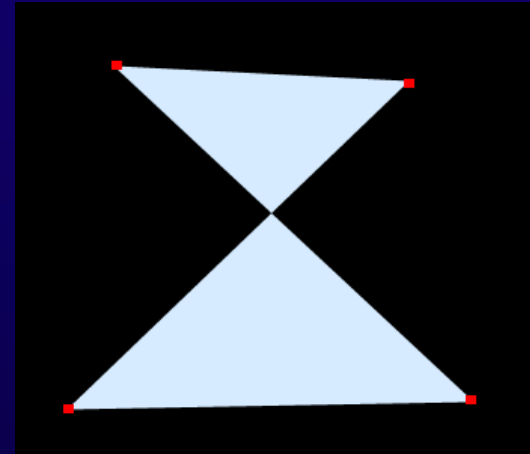

Edges that cross.

Antialiasing



- Scan conversion with super-sampling.
 - How can we achieve this? Two possibilities:
 1. Scan convert once to a super-sampled grid, then average down.
 - Cost:
 - 1 scan conversion
 - $s^2 \times p^2$ storage, where there are $(s \times s)$ samples per pixel, $(p \times p)$ image
 - $s^2 \times p^2$ pixel writes
 2. Perform many normal scan conversions at super-sampled locations, and additively combine them. You will implement this method using an **accumulation buffer**.
 - Cost:
 - s^2 scan conversions
 - $2p^2$ storage (not exactly for this assignment)
 - $s^2 \times p^2$ pixel writes
- (demo: overheads)

Motion Blur



- Your goal is to reduce temporal aliasing, **NOT** to produce an artistic effect.

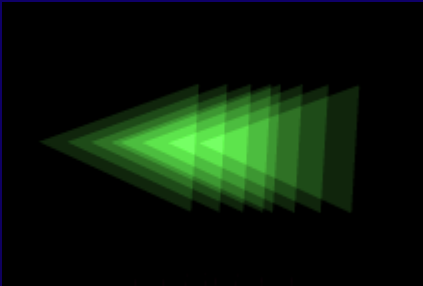

Accomplished by interpolating between *keyframes*, meaning you define certain positions at certain times, and for times in between you calculate the position and direction of motion.

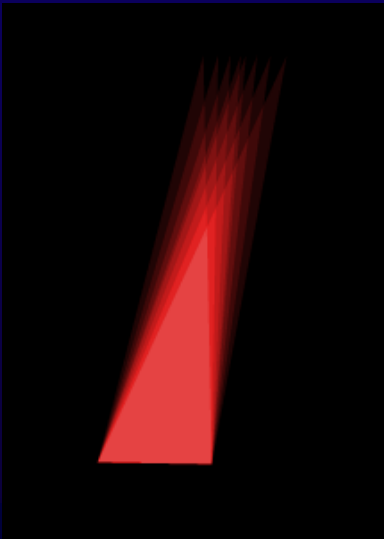

Multiple images at different sample times are blurred (using the *accumulation buffer*), creating the illusion of motion.

Accumulation Buffer Algorithm



- Allows us to successively render multiple “scenes” and have them additively blend as we go. Each image ends up with an equal weighting of $1/n$, where n is the number of samples taken.
- (Appendix A in project 2 handout)
- Let “canvas” be a $16 \times 3 = 48$ -bit pixel array, “temp” be a $8 \times 3 = 24$ -bit pixel array, and “polygon color” be a $8 \times 3 = 24$ -bit color value.
- 1 clear canvas to black;
- 2 $n = 0$ (number of samples taken so far)
- 3 for ($i=1$; $i \leq s$; $i++$) (for s subpixel positions)
- 4 for ($j=1$; $j \leq t$; $j++$) (for t fractional frame times)
- 5 clear temp to black
- 6 $n = n + 1$
- 7 for each polygon
- 8 translate vertices for this subpixel position and fractional frame time
- 9 for each pixel in polygon (using your scan converter)
- 10 temp color \leftarrow polygon color
- 11 for each pixel in canvas
- 12 canvas color \leftarrow canvas color + temp color
- 13 canvas color \leftarrow canvas color / n
- 14 convert canvas to 8×3 bits and display on screen (by exiting from your rasterizer)

Accumulation Buffer (cont.)



- Example (with overlap):

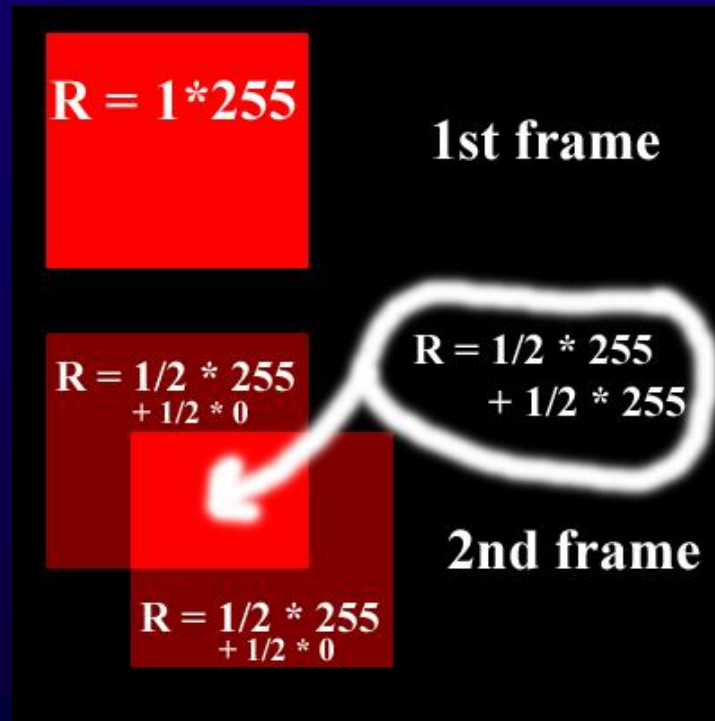

Accumulation Buffer (cont.)



- **Question: Why should we render all polygons at once per frame (lines 7-10), why not antialias the objects separately and then blend their images together?**
- **Answer: Polygons on a perfect mesh over a colored background will show some of the background color. Rendering the polygons together prevents any unwanted blending.**

Rasterization Notes



- **Question: Which pixels do we paint in 'edge' cases?**
- **Follow this general rule:**
 - If a sample lies within the ideal polygon, paint it.
 - If a sample lies outside the ideal polygon, don't paint it.
 - If a sample lies exactly on an edge/vertex, your choice.
- **This can result in gaps, which is a form of aliasing. Don't fix it!**
 - Antialiasing will fill in the gap

Slivers:

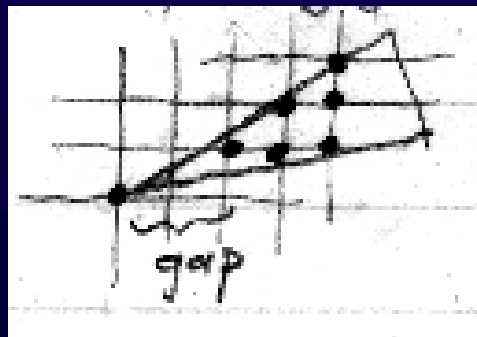

Floating Point Issues



- Discussed in FvD 19.2.3
- **The book presents 2 different schemes:**
 - Multiply to get rid of floating points, but by how much?
 - Store and calculate in floating point. Slower, but recommended.
- **The edge table algorithm already uses floating points when calculating slopes and adjusting edge x values.**
- **Our rasterizer allows floating point *vertices*.**
- **Generally, the algorithm doesn't change, but:**
 - The edge table still has integer buckets, so you must round to find the correct bucket, and adjust x_{\min} as appropriate.

Floating Point Issues (cont.)



- **Helpful Hint:**
- **Work through the edge table algorithm on a piece of lined paper, with each line representing a horizontal scan line.**
- **Try various rounding strategies, and see which gives the correct results.**

Extra Credit



- **(Extra Credit is fun!!!)**
- **1. Extend the interface to allow interactive scaling and rotations of polygons around a chosen point. Using matrices is one way...**
- **2. Extend the interface to allow insertion and deletion of vertices in an already-defined polygon. Not hard mathematically, but think of usability as well.**
- **3. Allow the number of vertices in a polygon to be different at any keyframe. Example: square to house.**

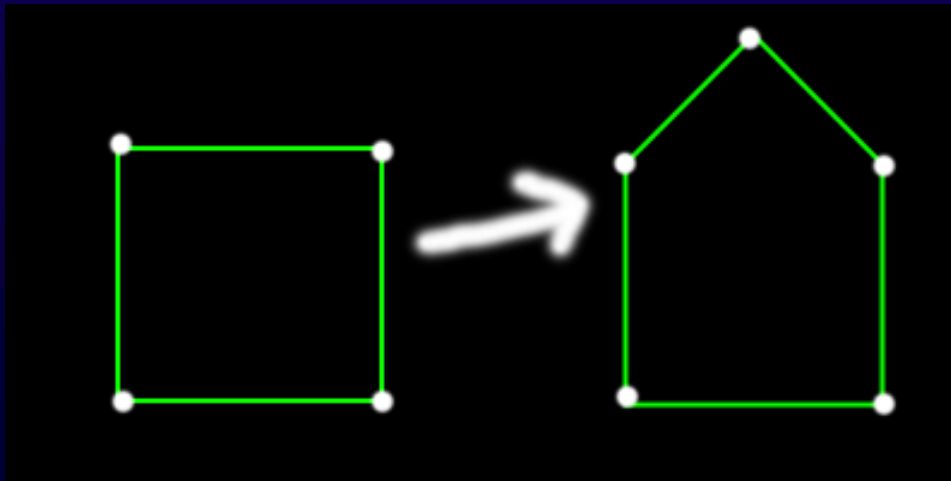

Extra Credit (cont.)



- **4. Extend the interface to allow the input of polygons with “curved” boundaries.** Curve is approximated by lots of closely spaced vertices that are still linearly connected. Not too tough, add vertices along mouse path while mouse button is down.
- **5. Combine #3 and #4 to allow different curved boundaries for each keyframe.** Calculate approximate locations for vertices when the number changes. For example, going from a curve with 10 vertices to one with 4, calculate points along the 4-vertex curve at 1/10 intervals. Or come up with a better scheme.

6. Replace linear interpolation with splined interpolation to create smoother transitions between keyframes. Refer to section 21.1.3 in text for more info. Consider cubic B-splines (section 11.2.3).

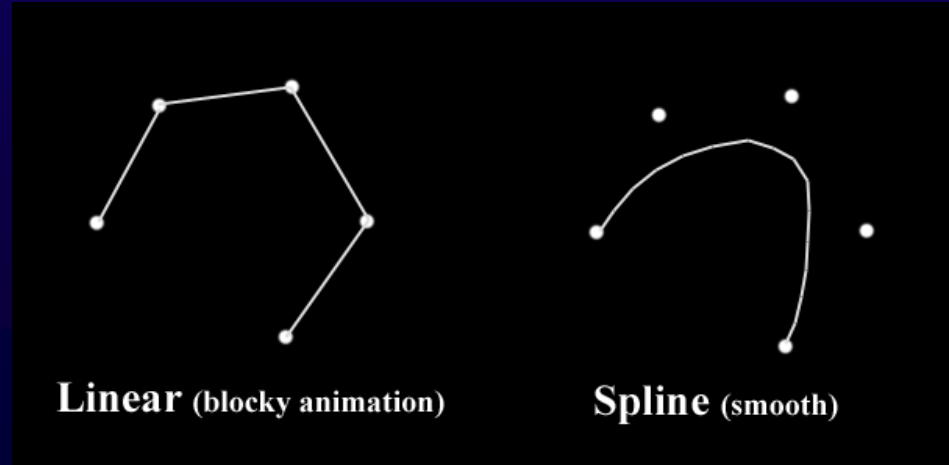

Extra Credit (cont.)



- 7. Implement polygon clipping.
 - Scissoring means not sending pixel values to the canvas when they would be out of bounds (this is the required functionality). Full clipping means trimming the edge of the polygon so it fits within the screen, which can greatly reduce the time spent performing rasterization.

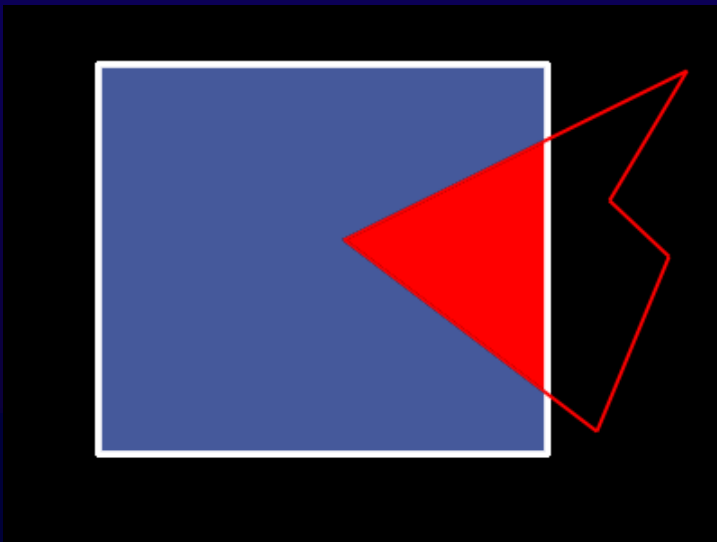

scissoring

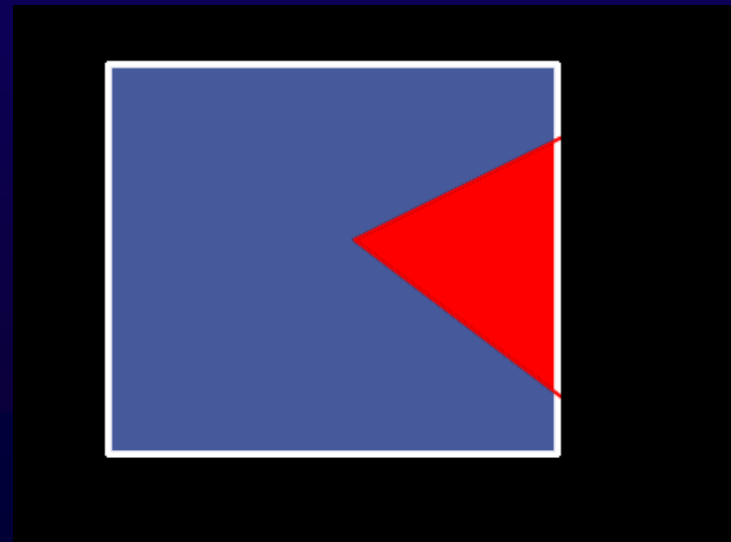

clipping

Extra Credit (cont.)



- 8. Implement unweighted area sampling (section 3.17.2 and earlier slide) as a user selectable alternative to accumulation buffer antialiasing (you must still implement accumulation buffer).
- For even more fun, implement *weighted* area sampling (section 3.17.3).
- 9. Create a cool animation and show it at the demo! Highly recommended!

Development Tips



- Your canvas has (0,0) at the top left, with (canvasWidth-1, canvasHeight-1) at bottom right. Examples in book have (0,0) at bottom left. Doesn't change too much, just be aware.
- If you are comfortable using them, you might find the C++ standard templates useful (especially sorted lists) for handling lists in your edge table.
- Alternatively, you might want to write your own class or functions to handle this.
- You only need to implement the Rasterize function in objects.cpp, unless you're doing extra credit.

Questions?

